

ATTACHMENT TYPE MICRO AIR GRINDER

# ROTUS Series

## ROTUS SERIES ◀◀



ROTUS Standard Set  
Code No. **1163** Model **ROTUS-IR**



- **Compatibility**  
Compatible with a variety of attachments ideal for any application.
- **High-power and High-torque**  
Equipped with an ultra-precision NAKANISHI special vane motor, this machine maintains a stable grinding process by maintaining the rotational speed even under fluctuating grinding loads.
- **Light-Weighted, Compact body**  
NAKANISHI products are focused on high precision and high quality, pursuing ideal ease of use, lightweight and a compact size, as well as exquisite balance and good handling.
- **A wide variety of tools**  
A wide variety of NAKANISHI original tools are available to support processing along with products.

**A Special Rotary Vane Air Motor is Incorporated**

The air motor utilizes a special vane design which keeps constant speed even under load, to provide stable grinding and polishing operation.

**Excellent quietness with Silencer**

By attaching the silencer to the end of the exhaust air tubing, the motor operates extremely quietly.

**Twist Free Hose**

The grinder and dual hoses (air supply and exhaust) are not fixed, and the hoses swivel freely 360° without twisting. (IM-301)

**30,000 min<sup>-1</sup>**



**13 Types of Attachments Available**

13 different types of attachments making an almost infinite number of applications possible.



※ ROTUS Attachment is compatible with Emax EVOLution. System Chart Emax EVOLution Series / ROTUS Series (p.1-9~10)

**Ring Type Attachment**

Code No.	<b>1147</b>	Model	<b>IR-310</b>
----------	-------------	-------	---------------

**ROTUS Air Motor**

Code No.	<b>1004</b>	Model	<b>IM-301</b>
----------	-------------	-------	---------------

**Set-Up Drawing**



■ Use Air Line Kit AL-H1207F or air supply 3 pieces set. (Air Filter, Air Regulator, Lubricator)

CAUTION  
Electric System  
Air System  
Ultrasonic  
General Parts  
Exclusive Tools

CAUTION  
Electric System  
Air System  
Ultrasonic  
General Parts  
Exclusive Tools

ROTUS Series System Chart

Code No. Model

Attachment

1147 IR-310



Ring Type

1005 IH-300



Lever Type

1016 HG-200

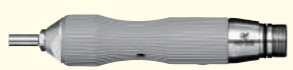

6 mm Torque Type

1017 BMH-300



Long Type

1012 MFC-300S



90° Mini Angle Type

1013 MFC-300M



90° Mini Angle Type (Very Small Head)

1006 IC-300



90° Angle Type

1014 KC-300



50° Angle Type

LUSTER

1302 LS-100



Pistol-Type Polisher (Reciprocating motion)

MINI-LUSTER

1307 ML-8



Pencil-Type Reciprocating Polishing Finisher (Reciprocating motion)

SWING-LUSTER

1380 SLS-16



Pencil-Type Reciprocating Polishing Finisher (Right to left motion)

Hammer Action Type

8060 HA-500



Engraving and Ornament Processing Work Hammer

FINE BELT SANDER

1146 KBS-101



Small-sized Handy Belt Sander

Speed Reducer-Extension Joint



Extension Joint  
1015 CN-01



1/4 Speed Reducer  
1009 RG-01



1/15 Speed Reducer  
1010 RG-02

※ Can be connected between the motor and the attachment when a higher level of torque is required.

Motor



• Air Motor with Hose 360° Twist-Free Joint Mechanism  
1004 IM-301 3,000~30,000 min<sup>-1</sup>

AIR DRIVEN

• Air Line Kit



4507 AL-H1207F

• Foot Controller



1064 AFC-45

※ This air line kit is designed for use with the AFC-45 Foot Controller, Code No.1064.

⚠ Details of Maximum Allowable speed on intermittent use or continuous use p.2-7~10

ROTUS SERIES

PRECISION HIGH TORQUE AIR MOTOR • STANDARD SET

# ROTUS Air Motor • Standard Set

3,000~30,000 min<sup>-1</sup>

- High performance air motor with high torque. The vane and cylinder, which are the result of NAKANISHI's ultra-precision machining expertise, minimize the decrease in rotational speed due to cutting load.
- This high performance air motor with minimal power loss from load fluctuation has excellent performance in its grinding stability. Moreover, the motor with minimal air consumption runs quietly and the energy-saving mechanism makes it possible to operate with a 0.75KW (1hp) air compressor.
- Lightweight and compact design. 130 g (w/o hose)
- 13 types of attachments for all types of applications.
- ON / OFF, FWD. / REV. Rotation Direction and Motor Speed can be controlled only by the Ring Switch.
  - Foot controller is available (p. 2-10) : variable speed control.
- Cooling system suppresses heat for continuous operation.
- By attaching the silencer to the end of the exhaust air tubing, the noise level can be reduced to an outstanding level.
- Twist-Free Joint mechanism is installed in the IM-301 to solve the problem of hose twisting.

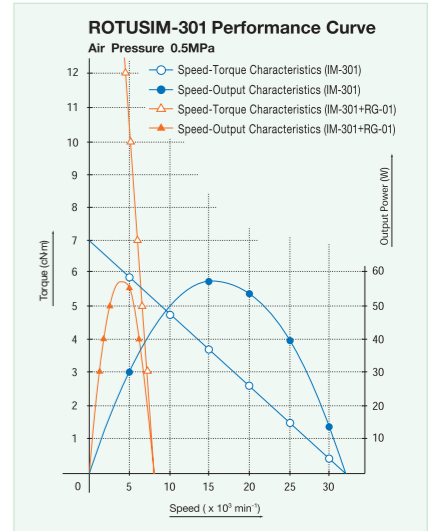

ROTUS Air Motor (with Twist-Free Joint Mechanism)

2,000~30,000 min<sup>-1</sup>

Code No. 1004 Model IM-301

- Speed : Max. 30,000 min<sup>-1</sup> (0.4 MPa)
- Proper Air Pressure : 0.3~0.45 MPa
- Air Consumption : 75 Nℓ / min
- Output Power : 46 W
- Max. Torque : 6.6 cN·m (0.4 MPa)
- Weight : 130 g (w/o hose)

Standard Accessories  
• Hose (K-206) : 2 m • Silencer (K-209) • Pin Wrench (K-233) : 1 pc.



<Air Motor with 360° Twist-Free Joint Mechanism>

- The Twist-Free Joint mechanism will avoid hose twisting.



ROTUS Standard Set



30,000 min<sup>-1</sup> (Speed)

The ROTUS System is a hand-held grinder with an energy saving air motor. Since it is an air driven system, there is virtually no heat generated to result in excellent durability. Select from a variety of attachments depending on the application.

The Ring type IR-310 is a standard attachment for the ROTUS standard set ROTUS-IR.

Code No. 1163 Model ROTUS-IR

- Standard Equipment
- Air Grinder (IR-310+IM-301) : 1 pc.
  - Collet ø3.0mm (CHH-3.0), ø2.35 mm (CHH-2.35) : 1 pc. each
  - Air Line Kit (AL-H1207F) : 1 pc. • Foot Controller (AFC-45) : 1 pc.
  - Accessories : Piping Hose 2m (K-275) : 1 pc., Lubricating Oil (K-211) : 1 pc. Wrench (7 x 5.1) : 1 pc., Pin Wrench (K-233) : 2 pcs. L Shaped Wrench (9) : 1 pc.

Specifications (IR-310 + IM-301)

Weight	Max. Torque	Speed	Proper Air Pressure	Air Consumption	Output Power	Collet
222g(※)	6.6 cN·m (0.4 MPa)	30,000 min <sup>-1</sup>	0.3~0.45 MPa	75 Nℓ /min	46 W (Motor)	ø0.3~ø3.175 mm CHH Group (p.4-3)

※ Weight (w/o Hose)

◆ Order by Code No.

### Ring Type Attachment

Code No. **1147** Model **IR-310**

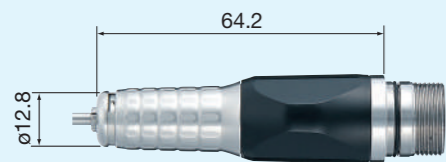

40,000 min<sup>-1</sup> Max.

- High precision and high reliability is realized by micron grade precision.
- Slim, lightweight design allows for fine finishing of delicate parts.
- One-touch ring type bur replacement.



◆ Weight : 92 g  
 Standard Size Collet  
 ø3.0 mm (CHH-3.0) ø2.35 mm (CHH-2.35)  
 Optional Collets : CHH Group are shown in page (p.4-3)  
 Standard Accessories  
 • Wrench (7 x 5.1) : 1 pc. • Pin Wrench (K-233) : 1 pc.  
 • L Shaped Wrench (9) : 1 pc.

### Lever Type Attachment

Code No. **1005** Model **IH-300**

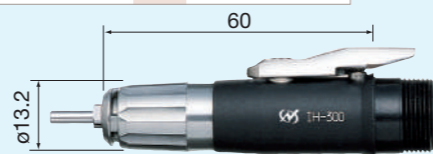

40,000 min<sup>-1</sup> Max.

- High precision and high reliability is realized by micron grade precision.
- Slim, lightweight design allows for fine finishing of delicate parts.
- Lever Type one touch bur release.



◆ Weight : 62 g  
 Standard Size Collet  
 ø3.0 mm (CHH-3.0) ø2.35 mm (CHH-2.35)  
 Optional Collets : CHH Group are shown in page (p.4-3)  
 Standard Accessories  
 • Wrench (7 x 5.1) : 1 pc.  
 • Pin Wrench (K-233) : 1 pc.

### SWING-LUSTER Attachment

Code No. **1380** Model **SLS-16**



30,000 min<sup>-1</sup> Max.

- High speed grinding and polishing operations can be performed while maintaining the fine and delicate feel of hand polishing.
- Lightweight pencil type design makes it easy to work in tight areas.
- Easily adjustable stroke length allows efficient work on minute areas or large sections.
- Weight : 127 g ◆ Stroke Range (variable) : 0~1.6 mm
- ◆ Reciprocating Stroke (variable) : 0~7,650 times/min
- ◆ Max. tool shank diameter ø5.0 mm, Screw clamp type

Standard Accessories  
 • Wrench (16 x 18), (20 x 24) : 1 pc. each  
 • Allen Wrench (1.5 mm) : 1 pc. • Standard Accessories : 1 set  
 Standard Accessories

Code No.	Description	Package
62510	Ceramic Fiber Grindstone Holder	1 pc. each
62814	Electroplated Diamond File 1.25 x 4 x 50 #100	
60520	Ceramic Fiber Grindstone 1 x 6 x 50 #1200	

### Hammer Attachment

Code No. **8060** Model **HA-500**

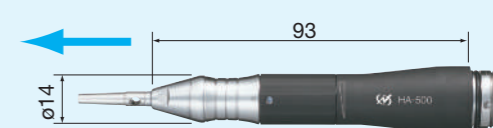

16,000 min<sup>-1</sup> Max.

Please use it with Speed Reducer.

- A wide variety of patterns can be produced by adjusting the spring pressure and hammer speed.
- Light weight, pencil type grip makes the handpiece very comfortable to hold and easy to use.
- Adjustable spring pressure. ◆ Weight : 95 g
- Self lubricating hammer mechanism ensure excellent durability.
- ◆ Stroke Range : 0.4 mm ◆ Stroke Times : 25~4,000 times/min
- ◆ Stroke Spring Pressure : 4.4~7.1 N (Ring Adjustment Type)

Standard Accessories  
 • Wrench (7 x 5.5) : 1 pc. • Bar Wrench (K-212) : 1 pc.  
 • Oil and Oil offer machine • Hammer Bit (For replacement) : 2 pcs.

Hammer Bit to be machined to required shapes (SUS-420, heat treated, approx, HRC50)

Code No.	Package
65301	3 pcs./pack

### 6 mm Torque Type Attachment

Code No. **1016** Model **HG-200**

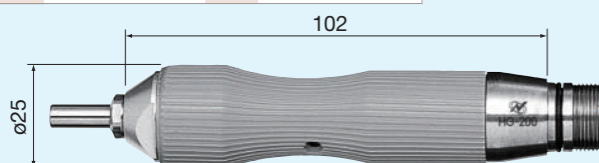

30,000 min<sup>-1</sup> Max.

Please use it with Speed Reducer.

- ø6.0 mm shank burs ready.
- The resistance produced by cutting and grinding is absorbed by a special rubber grip to eliminate slipping.
- The bur needs to be secured with a wrench.



◆ Weight : 210 g  
 Standard Size Collet  
 ø6.0 mm (CHG-6.0)  
 Optional Collets : CHG Group are shown in page (p.4-3)  
 Standard Accessories  
 • Wrench (10 x 10) : 1 pc. • Bar Wrench (K-212) : 1 pc.  
 • Pin Wrench (K-233) : 1 pc.

### Long Type Attachment

Code No. **1017** Model **BMH-300**

Tip diameter ø13 mm (For Deep Hole Grinding)



35,000 min<sup>-1</sup> Max.

- This unique slim body makes it ideal for cutting and grinding the bottom surface of deep ribs or holes.
- The bur needs to be secured with a wrench.



◆ Weight : 156 g  
 Standard Size Collet  
 ø3.0 mm (CHM-3.0)  
 Optional Collets : CHM Group are shown in page (p.4-4)  
 Standard Accessories  
 • Wrench (7 x 5.1), (6 x 4.5) : 1 pc. each  
 • Pin Wrench (K-233) : 1 pc.

### ROTUS Air Motor (with Chip Air Mechanism)

Code No. **1003** Model **IM-300**

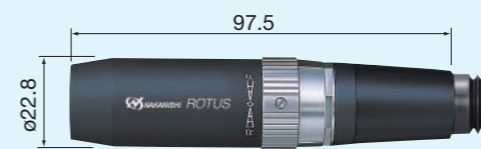

- ◆ Speed : 3,000~30,000 min<sup>-1</sup> ◆ Proper Air Pressure : 0.3~0.45 MPa
- ◆ Air Consumption : 75 Nl / min ◆ Output Power : 46 W
- ◆ Max. Torque : 6.6 cN·m (0.4MPa) ◆ Weight : 130 g (w/o hose)

Standard Accessories  
 • Hose (K-207) : 2 m • Silencer (K-209) • Pin Wrench (K-233) : 1 pc.

#### <Air Motor with Chip Air Mechanism>

- Air Motor with Chip Air Mechanism  
 Clean air is blown from the tip of the attachment to blow away cutting dust. The cooling effect reduces cutting heat and extends the life of the attachment.



### 90° Mini Angle Type Attachment

Code No. **1013** Model **MFC-300M**

For Chamfering Deep Hole, Bur Only ø1.6 mm

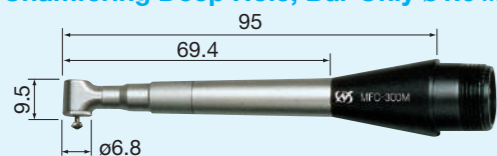

15,000 min<sup>-1</sup> Max.

Please use it with Speed Reducer.

- The smallest angle type attachment in NAKANISHI's lineup.
- Suitable for chamfering and deburring the inside of the slit pipe.

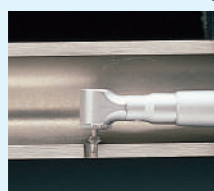

◆ Minimum Inner Diameter : ø13 mm  
 ◆ Holding tool width : 7.2 mm ◆ Weight : 47 g  
 ◆ Speed Reduction Ratio : 10/11  
 Standard Size Collet  
 ø1.6 mm (K-253) p.4-4  
 Standard Accessories  
 • Collet Wrench (K-232) : 1 pc. • Pin Wrench (K-233) : 1 pc.

### 90° Mini Angle Type Attachment

Code No. **1012** Model **MFC-300S**

For Chamfering Deep Hole, Bur Only ø1.6 mm

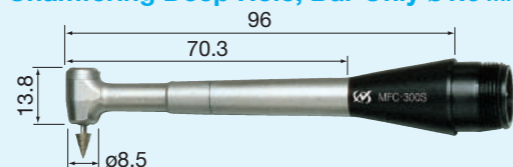

15,000 min<sup>-1</sup> Max.

Please use it with Speed Reducer.

- Suitable for chamfering and deburring the inside of the slit pipe.
- ◆ Minimum Inner Diameter : ø20 mm

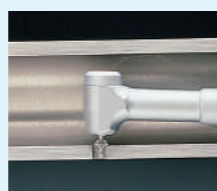

◆ Holding tool width : 11.9 mm  
 ◆ Weight : 50 g  
 ◆ Speed Reduction Ratio : 10/11  
 Standard Size Collet  
 ø1.6 mm (K-252) p.4-4  
 Standard Accessories  
 • Collet Wrench (K-232) : 1 pc. • Pin Wrench (K-233) : 1 pc.

### 90° Angle Attachment

Code No. **1006** Model **IC-300**

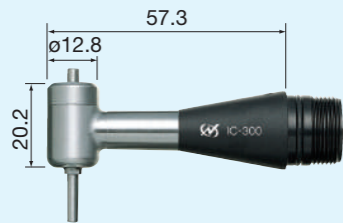

30,000 min<sup>-1</sup> Max.  
Please use it with Speed Reducer.

- Suitable for polishing a flat surface at speed with a grinding disk pad.
- Capable of applications for rough cutting to mirror finishing.
- Speed Reduction Ratio : 3/4



◆ Weight : 45 g  
◆ Standard Size Collet **3.0 mm (CHC-3.0)** **Exclusive Tools** p.5-25~30  
Optional Collets : CHC Group are shown in page (p.4-3)  
Standard Accessories  
• Collet Wrench (K-231) : 1 pc.  
• Pin Wrench (K-233) : 1 pc.  
• Standard Accessories : 1 set

Code No.	Description	Package
64101	Rubber Pad (Small) O.D. φ10 mm	1 pc./pack
64102	Rubber Pad (Med) O.D. φ20 mm	
64103	Rubber Pad (Large) O.D. φ30 mm	
64203	Sand Paper Disk for small pad φ11 #180	5 pcs./pack
64207	Sand Paper Disk for small pad φ11 #600	
64213	Sand Paper Disk for med. pad φ21 #180	
64217	Sand Paper Disk for med. pad φ21 #600	
64223	Sand Paper Disk for large pad φ31 #180	
64227	Sand Paper Disk for large pad φ31 #600	

### 50° Angle Attachment

Code No. **1014** Model **KC-300**

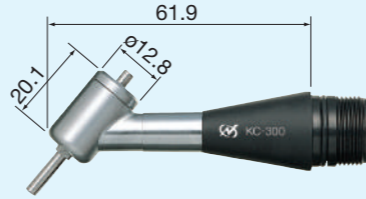

30,000 min<sup>-1</sup> Max.  
Please use it with Speed Reducer.

- Perfect for finishing bottom surfaces and other tight, hard to reach areas.
- Suitable for polishing a flat surface at speed with a grinding disk pad.
- Speed Reduction Ratio : 3/4

Use the motor in reverse rotation for clockwise rotation.



◆ Weight : 45 g  
◆ Standard Size Collet **3.0 mm (CHC-3.0)** **Exclusive Tools** p.5-25~30  
Optional Collets : CHC Group are shown in page (p.4-3)  
Standard Accessories  
• Collet Wrench (K-231) : 1 pc.  
• Pin Wrench (K-233) : 1 pc.  
• Standard Accessories : 1 set

Code No.	Description	Package
64101	Rubber Pad (Small) O.D. φ10 mm	1 pc./pack
64102	Rubber Pad (Med) O.D. φ20 mm	
64103	Rubber Pad (Large) O.D. φ30 mm	
64203	Sand Paper Disk for small pad φ11 #180	5 pcs./pack
64207	Sand Paper Disk for small pad φ11 #600	
64213	Sand Paper Disk for med. pad φ21 #180	
64217	Sand Paper Disk for med. pad φ21 #600	
64223	Sand Paper Disk for large pad φ31 #180	
64227	Sand Paper Disk for large pad φ31 #600	

### FINE BELT SANDER Attachment

Code No. **1146** Model **KBS-101**

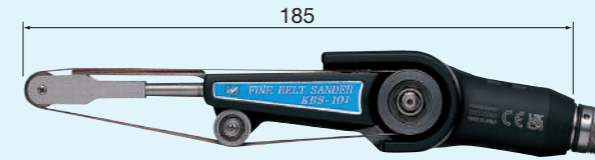

30,000 min<sup>-1</sup> Max.

- Very high belt speed, ideal for applications from deburring to finishing.
- The angle of the belt section is fully adjustable.



◆ Belt Speed : 0~705 m/min  
◆ Weight : 350 g  
◆ Belt Sizes : 4, 6, 8 mm Wide x 300mm long  
Standard Accessories  
• Allen Wrench (3 mm) : 1 pc.  
• Standard Accessories : 1 set  
**Exclusive Tools** p.5-32

Code No.	Description	Package
64902	Abrasive Belt Width 4 mm #120	2 pcs. each
64904	Abrasive Belt Width 4 mm #240	
64906	Abrasive Belt Width 4 mm #400	
64912	Abrasive Belt Width 6 mm #120	
64914	Abrasive Belt Width 6 mm #240	
64916	Abrasive Belt Width 6 mm #400	
64922	Abrasive Belt Width 8 mm #120	
64924	Abrasive Belt Width 8 mm #240	
64926	Abrasive Belt Width 8 mm #400	

### Air Line Kit

Code No. **4507** Model **AL-H1207F**



300(W) x 120(D) x 220(H) mm

This air line kit is designed for use with the AFC-45 Foot Controller, Code No.1064.

- Ensures a smooth operation and long life by supplying stable, conditioned air to the air motor.
- Three functions : air filter, regulator, mist lubricator can also be used to adjust motor speed.

◆ Weight : 2.2 kg ◆ Filter Mesh : 5 μm

Standard Accessories  
• Air Pressure Gauge • Air Regulator • Air Filter • Lubricator  
• Air Control Valve (CV-05) • Piping Hose (K-275) • Lubricating Oil (K-211)

### MINI-LUSTER Attachment (Pencil-Type Reciprocating Polishing Finisher)

Code No. **1307** Model **ML-8** Stroke (0.8 mm)

#### Reciprocating motion

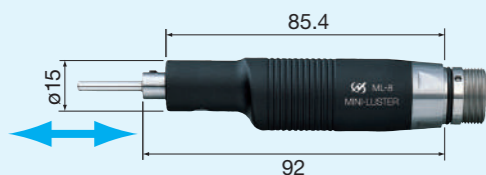

25,000 min<sup>-1</sup> Max.

- The pencil type grip is most suitable for polishing narrow grooves, details, etc.
- Stroke Range (Fixed) : 0.8 mm
- Reciprocating Stroke (Variable) : 0~6,380 times/min



◆ Weight : 130 g  
◆ Max. tool shank diameter φ3.5 mm, Screw clamp type  
Standard Accessories  
• Allen Wrench (1.5 mm) : 1 pc.  
• Standard Accessories : 1 set  
**Exclusive Tools** p.5-19~22

Code No.	Description	Package
62751	Spring Holder	1 pc./pack
62510	Ceramic Fiber Grindstone Holder	
62814	Electroplated Diamond File 1.25 x 4 x 50 #100	
60520	Ceramic Fiber Grindstone 1 x 6 x 50 #1200	

### LUSTER Attachment (Pistol-Type Polisher)

Code No. **1302** Model **LS-100**

#### Reciprocating motion



25,000 min<sup>-1</sup> Max.

- High performance grinding & polishing with high power and reciprocating stroke.
- Well-balanced, rubber-grip absorbs vibration.
- Stroke Range : 0~6 mm (variable)
- Reciprocating Stroke (variable) : 0~6,300 times/min



◆ Weight : 680 g  
◆ Max. tool shank diameter φ6.4 mm, Screw clamp type  
Standard Accessories  
• Allen Wrench (2 mm), (3 mm) : 1 pc. each  
• Lubricating Oil • Lubrication Nozzle for LUSTER  
• Standard Accessories : 1 set  
**Exclusive Tools** p.5-13~18

Code No.	Description	Package
62502	Stone Holder	1 pc./pack
62505	Stone Holder	
62751	Spring Holder	
62525	Rectangular Pad	
62526	Rod for Rectangular Pad	
62527	Angle Rod	10 pcs./pack
62552	Sand Paper Tip #120	
62555	Sand Paper Tip #320	
62557	Sand Paper Tip #600	
62559	Sand Paper Tip #1000	

### 1/4 Speed Reducer

Code No. **1009** Model **RG-01**



30,000 min<sup>-1</sup> Max.

- Mounted between an attachment and a motor.
- The speed is reduced to 1/4 while the torque is multiplied by 4 times.
- Suitable for high torque grinding process or drilling. ◆ Weight : 68 g

Standard Accessories  
• Pin Wrench (K-233) : 1 pc.

### 1/15 Speed Reducer

Code No. **1010** Model **RG-02**



30,000 min<sup>-1</sup> Max.

- Mounted between an attachment and a motor.
- The speed is reduced to 1/15 while the torque is multiplied by 15 times.
- Suitable for high torque grinding process or drilling.

◆ Weight : 93 g

Standard Accessories  
• Pin Wrench (K-233) : 1 pc.

### Foot Controller

Code No. **1064** Model **AFC-45**



This Foot Controller is necessary for use with the AL-H1207F Air Line Kit.

- Designed to depress from any direction.
- Fine adjustment of speed control is possible.

### Extension Joint

Code No. **1015** Model **CN-01**

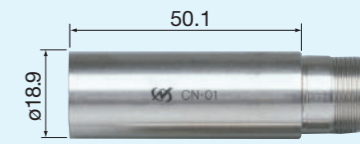

35,000 min<sup>-1</sup> Max.

- Speed Ratio 1 : 1
- This is a joint to be connected between a motor and an attachment to extend the total length of the attachment.

◆ Weight : 83 g

Standard Accessories  
• Pin Wrench (K-233) : 1 pc.

## For safe usage

- Please read operation manuals before using any NAKANISHI product.
- Please keep the operation manuals on hand so that the user can refer to them at any time.

## ⚠ Caution

Incorrect use of the product, or ignoring 'CAUTIONS for safety' described in the operating manuals may cause fatal or serious bodily injury.

## CAUTIONS

	<b>Always use safety glasses, masks, face guards for your safety.</b>		<b>Select proper hand tools and for your application.</b> Select tools carefully considering the performance of the hand tools, work procedure and type / shape of the material.
	<b>Do not touch the tools and hand tools when in operation.</b> Make sure the work area is neat and there is sufficient light.		<b>Do not wear loose clothing and/or accessories that may be caught in machinery.</b> Long hair should be tied prior to machine operation.
	<b>Do not operate the products where flammable liquids or gases exist.</b>		<b>Fix the work material firmly in a vise and/or other clamping fixture.</b>
	<b>Do not leave the work area with the hand tools still in operation.</b> Confirm that the hand tools have completely stopped after switching them off.		<b>Perform an inspection before use.</b> Clean the inside of the collet and tool shank, chips or fine metals inside the collet could cause tool slippage and result in damage to machinery or bodily injury.

	<b>Fasten the chuck firmly.</b> Make sure the tool is intact in the chuck to avoid tool slippage.		<b>Do not apply high pressure or pry to the tools.</b> This can break and/or bend the tools. Use the tools within their design limitation. Excessive pressure will decrease the efficiency of your work and cause excessive wear of the tools.										
	<b>Do not use damaged or broken electric cords and air hoses.</b>		<b>Check the tools carefully before use.</b> Confirm that the tools are free of chips, cracks, splits, scratches, lack of bonding, deformation, etc.										
	<b>Start at low speed and gradually increase to insure safe work.</b> This is particularly important for the use of new tools, large cutting tools and elastic tools such as rubber grindstone, sander and brush tools.		<b>Stop grinding or polishing immediately whenever unusual sounds, vibrations, or wear are found.</b> Restart the work only after the problem is solved.										
	<b>Store the tools and hand tools in a cool and dry place.</b>		<b>Only use attachments, parts, consumable articles and accessories produced by NAKANISHI INC.</b>										
	<b>The tools should be used by taking care of the overhang and below maximum allowable speed.</b> The catalogue shows the maximum allowable speed at 10 mm overhang (distance between the face of the collet and the top of the tool shank).	<p>Decrease the speed as shown in the table below, if you are using a longer overhang than 10 mm.</p> <table border="1"> <thead> <tr> <th>Overhang</th> <th>Maximum allowable speed (min<sup>-1</sup>)</th> </tr> </thead> <tbody> <tr> <td>Less than 10 mm</td> <td>Shown in the catalogue (A)</td> </tr> <tr> <td>Less than 20 mm</td> <td>(A) x 0.5</td> </tr> <tr> <td>Less than 25 mm</td> <td>(A) x 0.3</td> </tr> <tr> <td>Less than 50 mm</td> <td>(A) x 0.1</td> </tr> </tbody> </table>		Overhang	Maximum allowable speed (min <sup>-1</sup> )	Less than 10 mm	Shown in the catalogue (A)	Less than 20 mm	(A) x 0.5	Less than 25 mm	(A) x 0.3	Less than 50 mm	(A) x 0.1
Overhang	Maximum allowable speed (min <sup>-1</sup> )												
Less than 10 mm	Shown in the catalogue (A)												
Less than 20 mm	(A) x 0.5												
Less than 25 mm	(A) x 0.3												
Less than 50 mm	(A) x 0.1												

The pages are organized by code number, so you can find the code number you need by checking the code numbers printed at the top of the left and right pages.

### SHANK DIAMETER

SHANK  $\phi 3.0$

Indicates the shank diameter of various types of shafted tools.

※ NAKANISHI micro grinders use a collet system to maintain high precision. Please prepare a collet that corresponds to each shank diameter.

### Grit Size (Mesh Size)

#180

This indicates the size (roughness) of the abrasive grains used in various types of polishing / grinding materials. The larger the number, the smaller (finer) the grit size, and conversely, the smaller the number, the larger (coarser) the grit size (roughness). This is the most significant factor that affects the roughness of the finished surface.

- Rough Finishing ..... 46, 54, 60, 70, 80, 90
- Pre Finishing ..... 100, 120, 150, 180
- Middle Finishing ..... 220, 240, 280, 320, 400
- Finishing ..... 500, 600, 700, 800, 1000
- Extra Fine to Mirror Finishes ..... 1200, 1500, 1800, 2000, 3000, 4000, 6000, 8000...

### Maximum Allowable Speed

30,000 min<sup>-1</sup>

Do not exceed the maximum allowable speed. For safety reasons, always use below the indicated allowable speed.

If this is the first time you are using the equipment or tip tool, start with a low speed and gradually increase it to reach the most appropriate speed for use.

Conditions may vary depending on the type, shape, overall length, and wear condition of the tip tool, so please work with constant care.

※ The maximum allowable operating speed is for when the overhang is under 10 mm. If the overhang is more than 10 mm, please reduce the speed.

For details, please refer to "Precautions for use" on page A-3~4.

※ Make sure there are no mechanical defects in the equipment prior to each use.

Actual size illustration (excluding some tools and overall length)

Shank diameter of the tools listed on the facing page

The beginning of the Code Numbers listed on the facing page. (The last number listed is found on the right side.)

### Quantity in Standard Package

1 pc./pack

A standard package is the minimum shipping unit. This number shows the number of pieces in the standard package (bag, box, etc.). Please order the number of packages needed for the desired quantity.

11131~



**Angle Type Grinder  
(Electric / Pneumatic)**  
Exclusive Tools for "MINI ANGLE Type"

NAKANISHI Angle Grinders are available with a wide range of tools for a variety of machining operations, from cutting to grinding, polishing and lapping.

SHANK DIAMETER

SHANK  $\phi 1.6$

MINI Angle Type

**Diamond Burs for Deep Hole Chamfering**

SHANK  $\phi 1.6$  1 pc./pack

Diamond Burs for Deep Hole Chamfering

- Ideal for machining hardened steel, cemented carbide, ceramics, etc.



11131

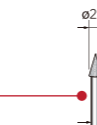

11132

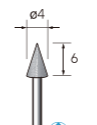

11133

SHANK  $\phi 1.6$  1 pc./pack

Diamond Burs for Deep Hole Chamfering



11151

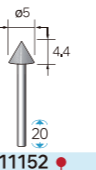

11152

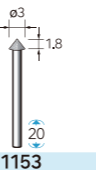

11153

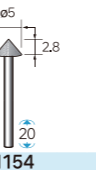

11154

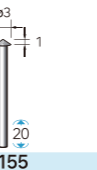

11155

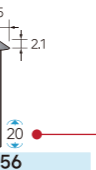

11156



Diamond Burs

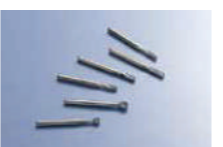

Carbide Burs



Mounted Abrasive Points



Abrasive Rubber Points

Photograph of the basic shape

Maximum Allowable Speed  
Grit Size

Quantity in Standard Package

Overall length

Code No. (Order Number)

Note : Specifications may change without notice. The color of the tools in the catalog may differ from the actual color due to printing and other factors.

### SHANK DIAMETER

Original tools that assist the LUSTER's powerful polishing ability to realize a speedy finish.  
We have a wide variety of tools for a wide range of processes from filing to mirror finish.

- ▶ SHANK  $\phi 3.0$
- ▶ SHANK  $\phi 3.2$

Handy Type (reciprocating)  
Tools for LUSTER



### Grindstone Holder

1 pc./pack Maximum clampable thickness 4.5 x width 11 mm

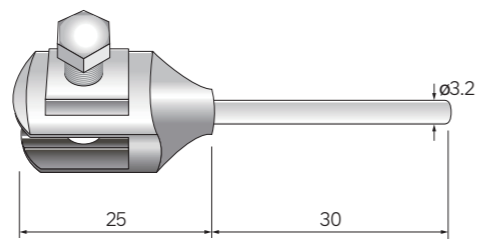
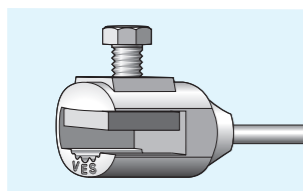

Code No.  
**62502**

1 pc./pack Maximum clampable thickness 11 x width 13.5 mm

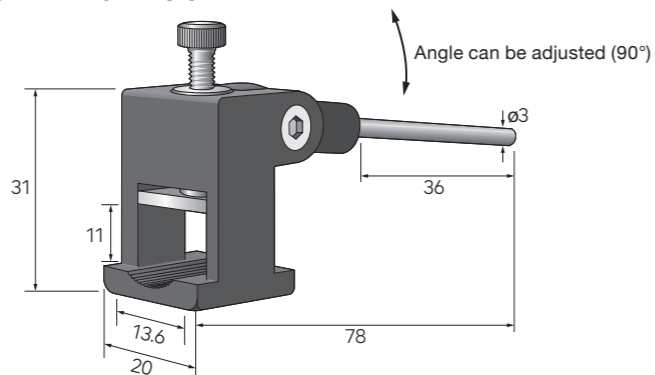

Code No.  
**62505**

### Ceramic Fiber Holder・Grindstone Holder

1 pc./pack Maximum clampable thickness 1 x width 4 mm

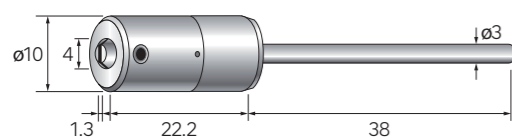

Code No.  
**62506**

Maximum clampable thickness 1 x width 10 mm

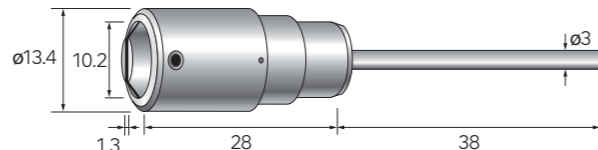

Code No.  
**62508**

Maximum clampable thickness 1 x width 6 mm

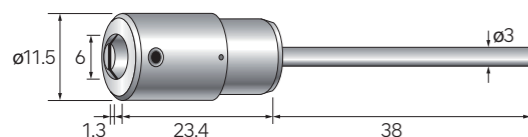

Code No.  
**62507**

Grindstone Holder  
Maximum clampable thickness 3 x width 6 mm

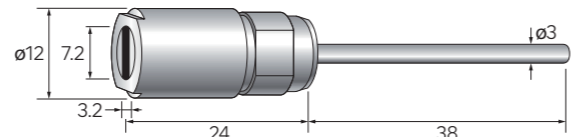

Code No.  
**62509**

### Flat Tip Holder

Attach the following Sandpaper and various polishing sheets.

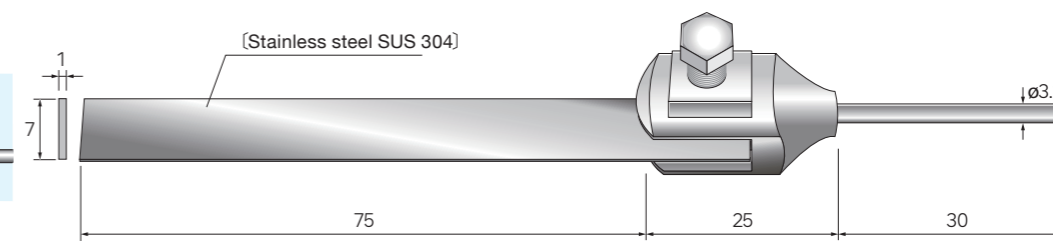
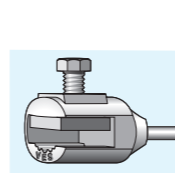

Code No.  
**62512**

### Square Pad Holder

The holder for polishing tips is ideal for polishing the bottom of a box shape.  
The damper function allows the holder to continuously fit the work surface, and the angle can be freely adjusted to continuously capture the work surface for efficient polishing.

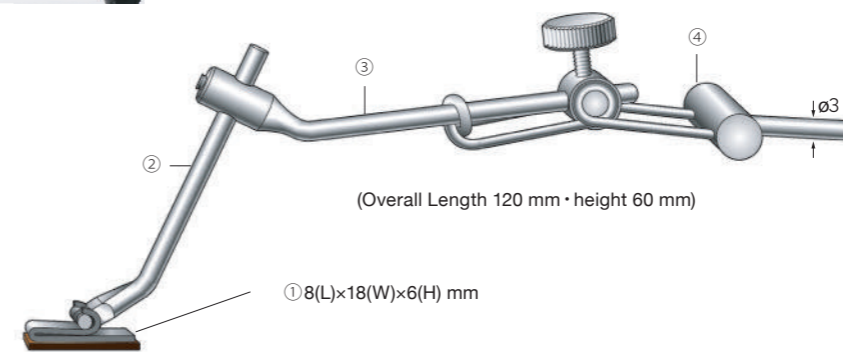

Code No.  
**62521**

Parts	Code No.
① Rectangular Pad	<b>62525</b>
② Rod for Rectangular Pad	<b>62526</b>
③ Angle Rod	<b>62527</b>
④ Tool Holder with Spring	<b>62751</b>

※ Parts can be ordered separately.

### Sandpaper

Please attach to a flat tip holder or rectangular pad holder.

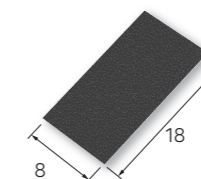

Grit Size	Code No.
# 120	<b>62552</b>
# 320	<b>62555</b>
# 600	<b>62557</b>
# 1000	<b>62559</b>

SHANK DIAMETER



Original tools that assist the LUSTER's powerful polishing ability to realize a speedy finish.  
We have a wide variety of tools for a wide range of processes from filing to mirror finish.



- Suitable for finishing of high-hardness metals such as mold steel (removal of hardened electroplated layer, etc.) and heat treated metal. Also suitable for polishing of cemented carbide molds, aluminum molds, and copper alloy molds.
- Ideal for grinding and polishing fine parts and rib slits of various molds for plastics, press, forging, headers, die-casting, etc.
- It can be used for grinding and polishing ceramics, precision electronic parts, and precision mechanical parts.
- It can handle a wide range of processing, from grinding of complex shapes and minute parts to mirror-polished finishes.

Handy Type (reciprocating)  
Tools for LUSTER

### Electroplated Diamond File

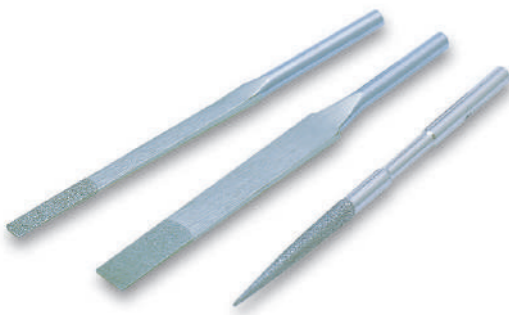

- <Features>
- Diamond abrasive grains are electroplated to the file surface (electroplated coating).
  - The amount of protruding diamond grains is large, and the cutting performance is excellent.
  - We use carefully selected diamond abrasive grains and electroplate them particularly strongly for machine finishing, so they have excellent durability.
  - It is suitable for finishing of high-hardness metals such as mold steel, heat treated metal, cemented carbide, and ceramics, polishing and finishing of various molds, and deburring and correction of machine parts.



### Tool Holder with Spring



Common Tools for LUSTER and MINI-LUSTER

- <Features>
- This is a utility holder that allows files and various tools to fit the abrasive tip to the work surface by the spring damper function.
  - The damper function absorbs all the vertical movement (flapping and bouncing) of the abrasive tool during reciprocating motion, enabling ideal reciprocating motion.
  - This makes it possible to apply the grinding tool flatly to the work surface, resulting in highly efficient even and smooth surfaces.
  - Diamond files, various files, ceramic fiber grindstones (Ø3 mm), various lapping sticks, various holders, etc. can be installed and used.

SHANK Ø3.0 1 pc./pack Electroplated Diamond File The illustrations on this page are 80% of the actual size.

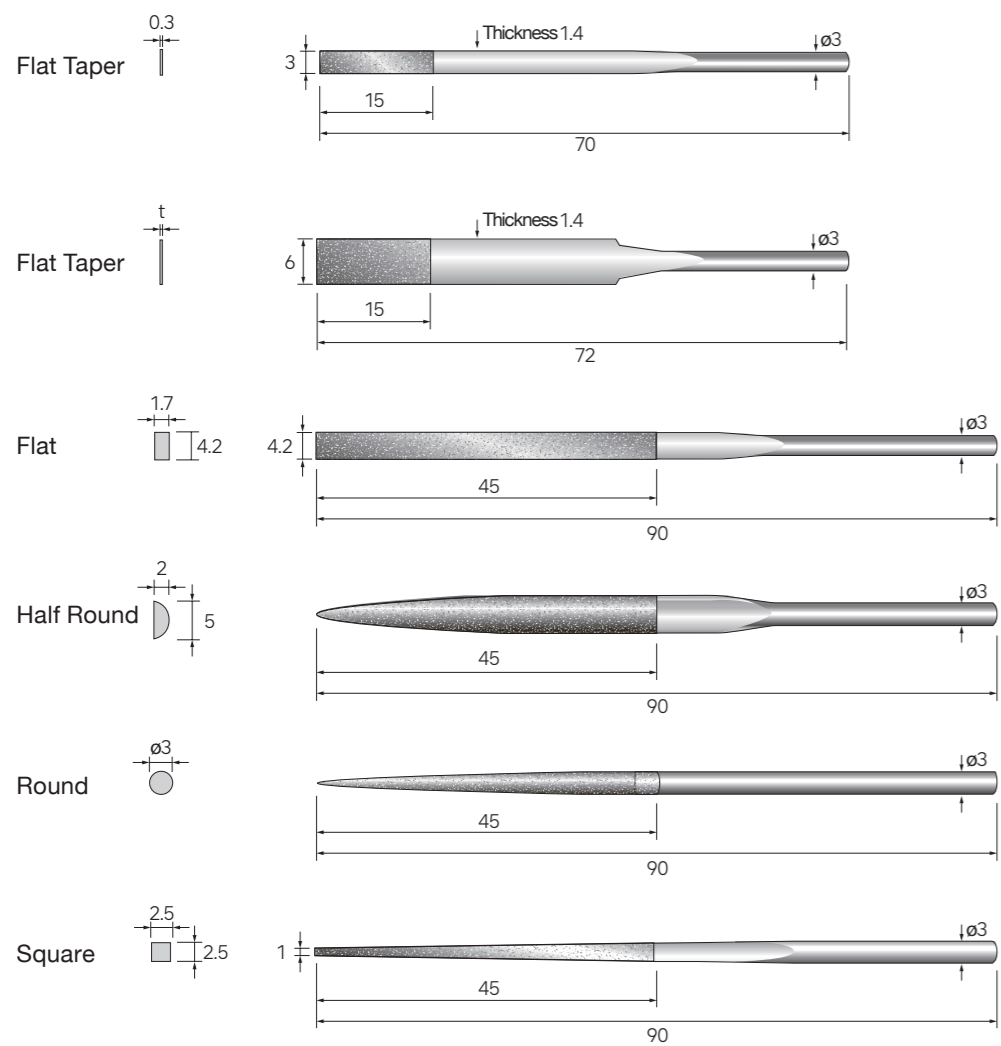

Grit Size	Code No.
#200	62301
#400	62302
#600	62303

Thickness (t)	Grit Size	Code No.
0.45	#200	62305
0.4	#400	62306
0.35	#600	62307

#150	62311
------	-------

#150	62313
------	-------

#150	62315
------	-------

#150	62317
------	-------

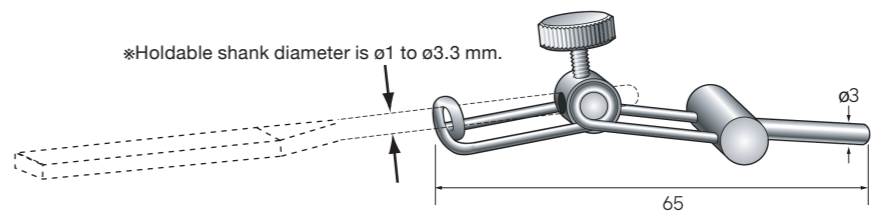

Code No.  
62751



# 57301~

SHANK DIAMETER

SHANK  $\phi 3.0$



## Handy Type Reciprocating Grinder (Electric / Pneumatic) Exclusive Tools for "LUSTER"

Original tools that assist the LUSTER's powerful polishing ability to realize a speedy finish. We have a wide variety of tools for a wide range of processes from filing to mirror finish.



# ~57410

Handy Type (reciprocating)  
Tools for LUSTER

### Precision Finishing File (Flat, Round, Square, Triangular, Half-Round)

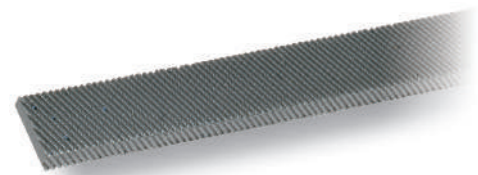

<Features>

- Ideal for precision finishing of general steel, brass, copper alloy, hard resin, etc.
- Carefully selected materials and advanced grading technology provide superior sharpness and durability.
- Speedy finishing is possible by using the LUSTER series (Electric / Pneumatic).

### Coarse File for Plastic and Woodworking (Flat, Round, Square, Triangular, Half-Round)



<Features>

- Ideal for filing wood products, plywood, compressed materials, and plastics.
- It is characterized by its superior sharpness and durability due to its advanced grading technology.
- It can be used with the Luster Series (Electric / Pneumatic) for speedy finishing.

SHANK  $\phi 3.0$  3 pcs./pack

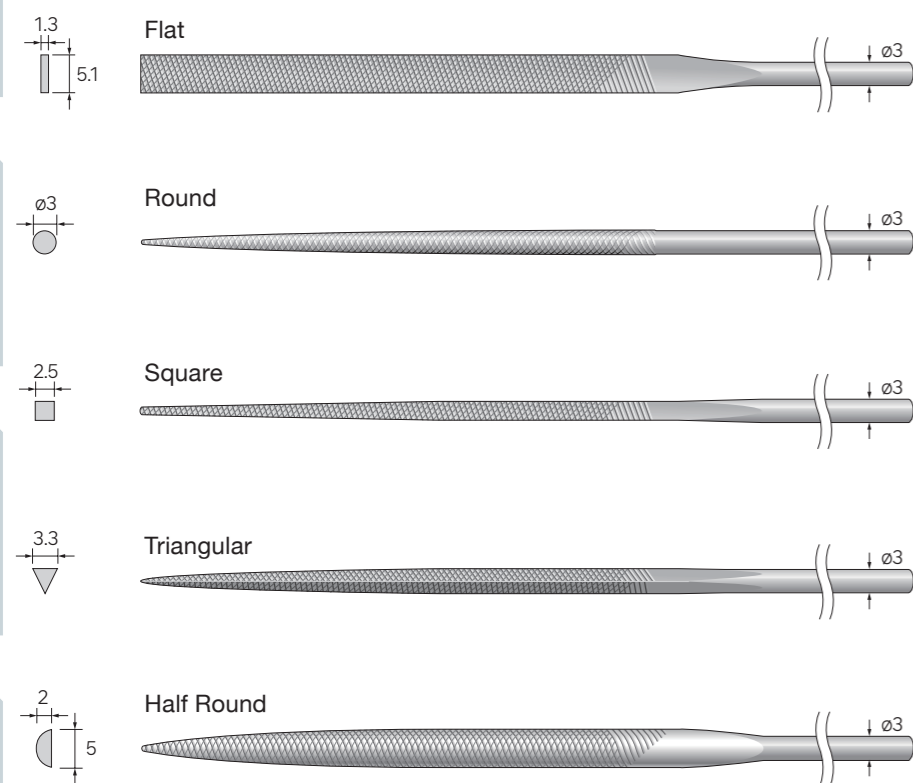

Overall length / 140 mm, Filing area / 70 mm

Medium-Grit		Fine-Grit	
Code No.		Code No.	
57301	Flat	57311	Flat
57302	Round	57312	Round
57303	Square	57313	Square
57304	Triangular	57314	Triangular
57305	Half Round	57315	Half Round

Set of 5 types

Precision Finishing File Medium-Grit Set  
(No.57301~No.57305 Contains 1 pc. each)

No.57309

Precision Finishing File Fine-Grit Set  
(No.57311~No.57315 Contains 1 pc. each)

No.57319

SHANK  $\phi 3.0$  3 pcs./pack

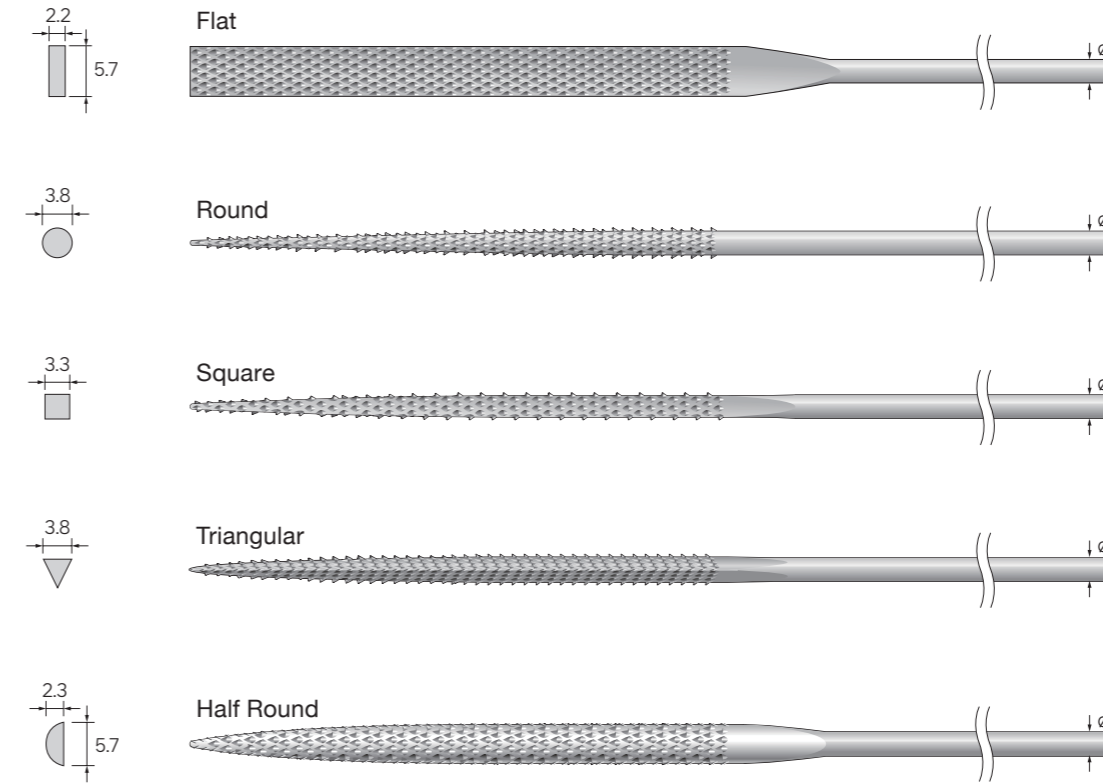

Overall length / 140 mm  
Filing area / 69 mm

Code No.	
57401	Flat
57402	Round
57403	Square
57404	Triangular
57405	Half Round

Set of 5 types

Coarse File Plastic and Woodworking Set  
(No.57401~No.57405 Contains 1 pc. each)

No.57410

# 62506~

SHANK DIAMETER

- SHANK  $\phi 3.0$
- SHANK  $\phi 3.2$



## Pencil Type Reciprocating Grinder (Electric / Pneumatic) Exclusive Tools for Polisher "MINI-LUSTER"

Designed to be easy to use, taking advantage of the features of the lightweight pencil type. The line-up of NAKANISHI's original tools is ideal for delicate and precise abrasive finishing.

# (~62982)

Pencil Type (reciprocating) Tools for MINI-LUSTER

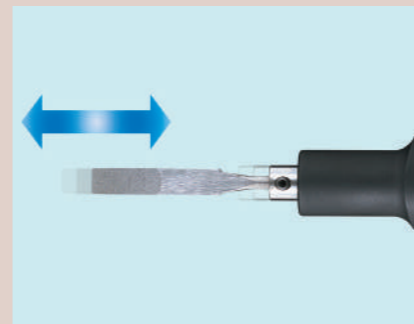

1 pc./pack

### Ceramic Fiber Holder·Grindstone Holder

Maximum clampable thickness 1 x width 4 mm

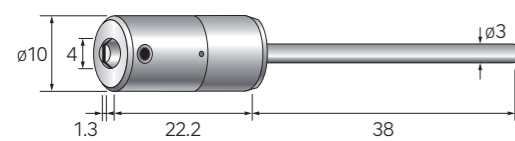

Code No.  
**62506**

Maximum clampable thickness 1 x width 10 mm

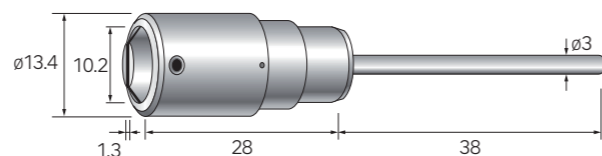

Code No.  
**62508**

Maximum clampable thickness 1 x width 6 mm

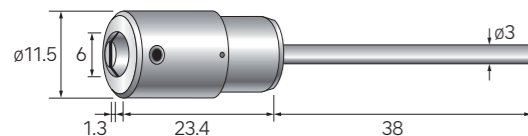

Code No.  
**62507**

Grindstone Holder  
Maximum clampable thickness 3 x width 6 mm

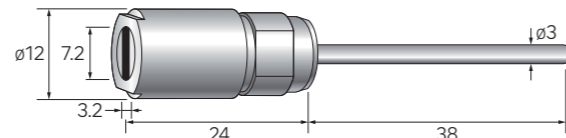

Code No.  
**62509**

Maximum clampable thickness 1 x width 6 mm

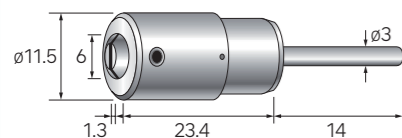

Code No.  
**62510**

2 pcs./pack

### Ceramic Fiber Grindstone

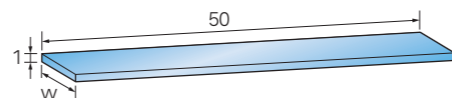
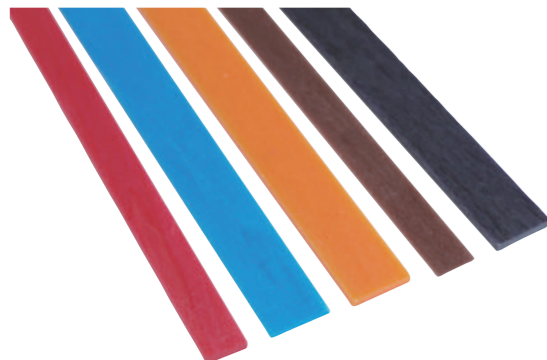

Grit Size	Color	W=4 mm	W=6 mm	W=10 mm
		Code No.	Code No.	Code No.
# 120	Violet	60511	60516	60521
# 220	Brown	60512	60517	60522
# 400	Orange	60513	60518	60523
# 800	Blue	60514	60519	60524
# 1200	Red	60515	60520	60525

1 pc./pack

### Flat Tip Holder

- A variety of polishing tips can be attached to MINI-LUSTER for efficient finish polishing.
- In addition to the polishing tips listed below, a wide range of cut polishing sheets (diamond film, felt sheets, etc.) can be used.
- The compact holder can be mounted on the pencil type MINI-LUSTER in a well balanced manner and is easy to use.

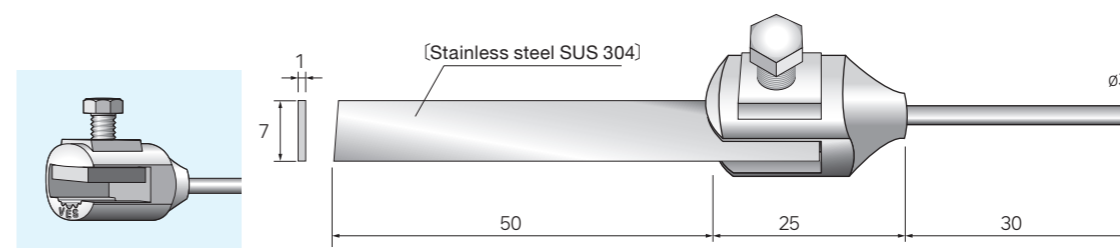

Code No.  
**62982**

100 pcs./pack

### Sandpaper

Please attach to a flat tip holder or rectangular pad holder.

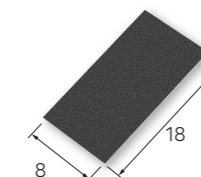

Adhesive Back	
Grit Size	Code No.
# 120	62552
# 320	62555
# 600	62557
# 1000	62559

1 pc./pack

### Tool Holder with Spring



<Features>

- This is a utility holder that allows files and various tools to fit the abrasive tool to the work surface by the spring damper function.
- The damper function absorbs all the vertical movement (flapping and bouncing) of the abrasive tool during reciprocating motion, enabling ideal reciprocating motion.
- This makes it possible to apply the grinding tool flatly to the work surface, resulting in highly efficient, even and smooth surfaces.
- Diamond files, various files, ceramic fiber grindstone ( $\phi 3$  mm), various lapping sticks, various holders, etc. can be installed and used.

\*Holdable shank diameter is  $\phi 1$  to  $\phi 3.3$  mm.

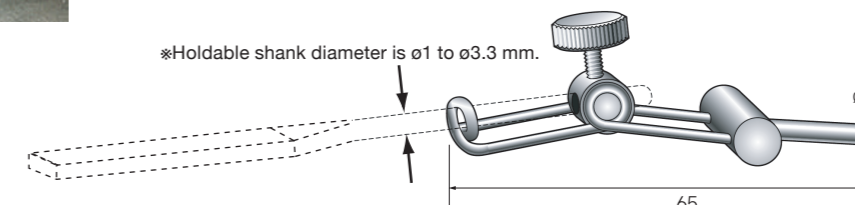

Code No.  
**62751**

# 62801 ~

SHANK DIAMETER

SHANK  $\phi 3.0$



## Pencil Type Reciprocating Grinder (Electric / Pneumatic) Exclusive Tools for Polisher "MINI-LUSTER"

Designed to be easy to use, taking advantage of the features of the lightweight pencil type. The line-up of NAKANISHI's original tools is ideal for delicate and precise abrasive finishing.

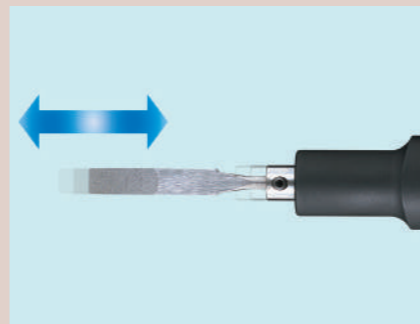

# ~62883

Pencil Type (reciprocating) Tools for MINI-LUSTER

### Electroplated Diamond File



#### <Features>

- Diamond abrasive grains are electroplated to the file surface (electroplated coating).
- The amount of protruding diamond abrasive grains is large, and the cutting performance is excellent.
- We use carefully selected diamond abrasive grains and electroplate them particularly strongly for machine finishing, so they have excellent durability.
- It is suitable for finishing of high-hardness metals such as mold steel, heat treated metal, cemented carbide, and ceramics, polishing and finishing of various molds, and deburring and correction of machine parts.

SHANK  $\phi 3.0$  1 pc./pack Electroplated Diamond File

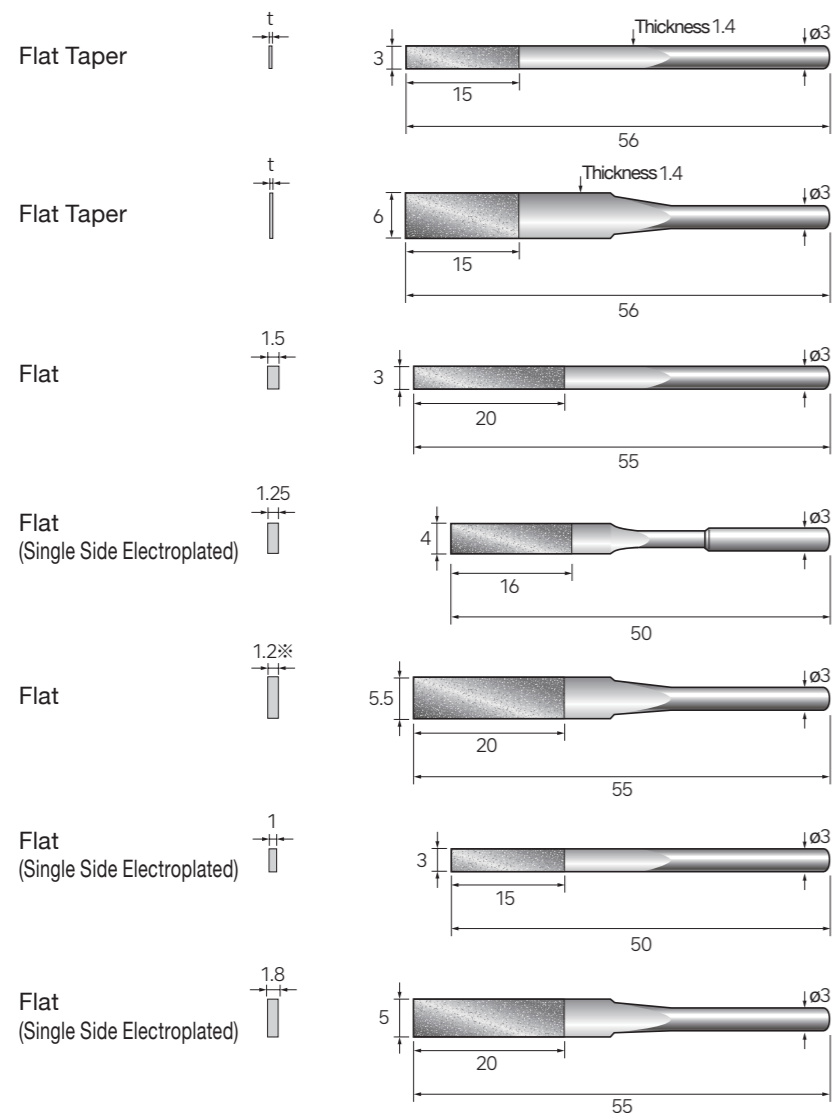

Thickness (t)	Grit Size	Code No.
0.5	#200	62801
0.4	#400	62802
0.35	#600	62803

0.5	#200	62805
0.4	#400	62806
0.35	#600	62807

#150	62811
#200	62812
#400	62813

#100	62814
------	-------

#150	62815
#200	62816
#400	62817

\* Thickness of 62815 is 1.4 mm.

#150	62821
#200	62822
#400	62823

#150	62825
#200	62826
#400	62827

SHANK  $\phi 3.0$  1 pc./pack Electroplated Diamond File

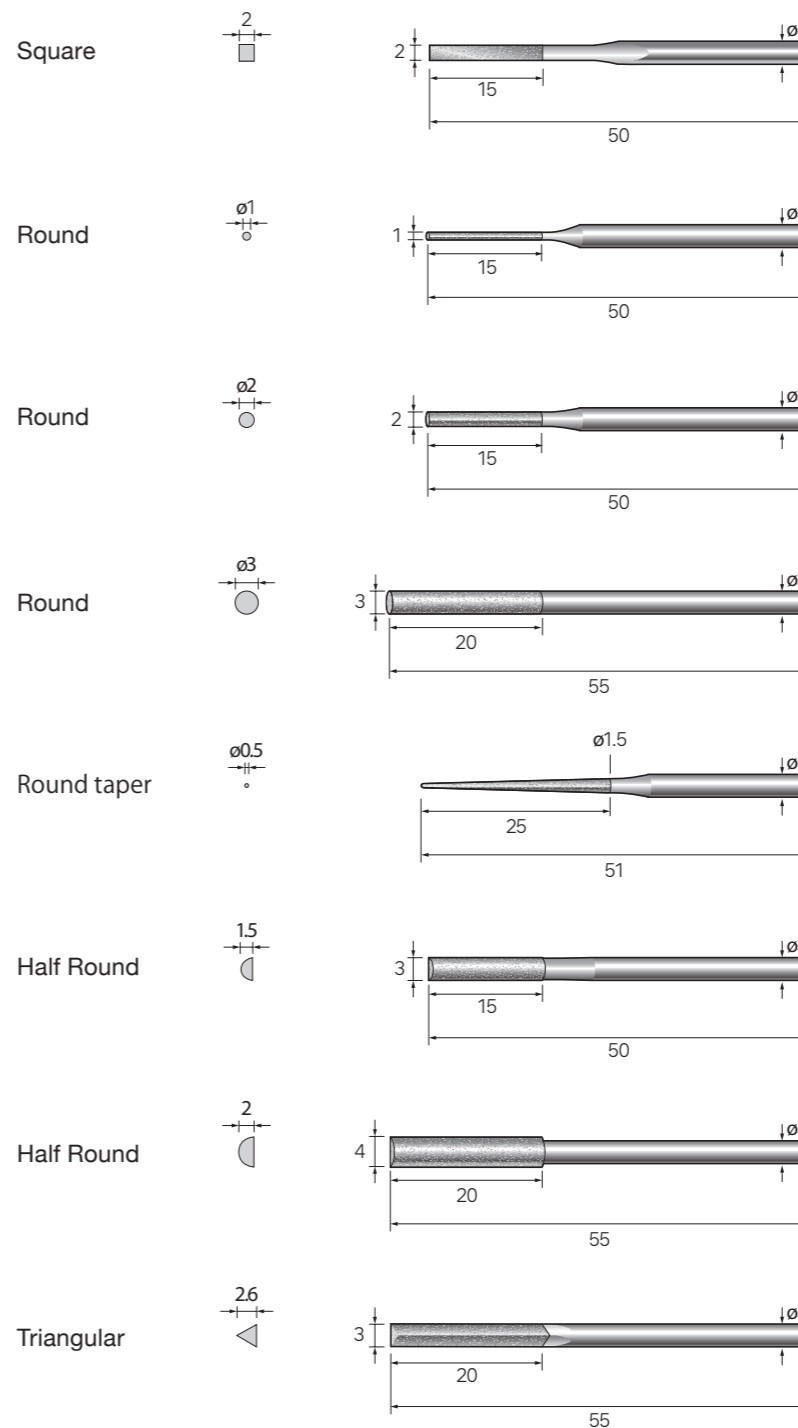

Grit Size	Code No.
#150	62831
#200	62832
#400	62833

#100	62840
#150	62841
#200	62842
#400	62843

#150	62845
#200	62846
#400	62847

#150	62851
#200	62852
#400	62853

#150	62855
#200	62856
#400	62857

#150	62865
#200	62866
#400	62867

#150	62871
#200	62872
#400	62873

#150	62881
#200	62882
#400	62883

(51123~)

SHANK DIAMETER

SHANK  $\phi$ 3.0

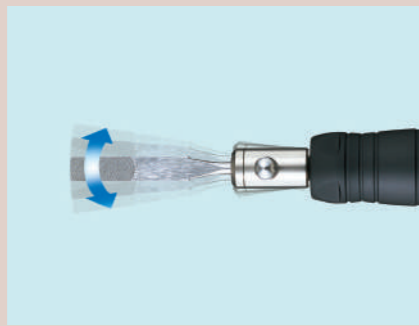

### Pencil Type Swing Polisher (Electric / Pneumatic) Exclusive Tools for "SWING-LUSTER"

The left-right horizontal swinging file swings around narrow areas (ribs), corners, grooves (runners), etc., which cannot be polished with a reciprocating file, to achieve speedy polishing.

(~62827)

Pencil Type (swing) Tools for "SWING-LUSTER"



### Electroplated Diamond File



#### <Features>

- Diamond abrasive grains are electroplated to the file surface (electroplated coating).
- The amount of protruding diamond abrasive grains is large, and the cutting performance is excellent.
- We use carefully selected diamond abrasive grains and electroplate them particularly strongly for machine finishing, so they have excellent durability.
- It is suitable for finishing of high-hardness metals such as mold steel, heat treated metal, cemented carbide, and ceramics, polishing and finishing of various molds, and deburring and correction of machine parts.

### SHANK $\phi$ 3.0 1 pc./pack Electroplated Diamond File

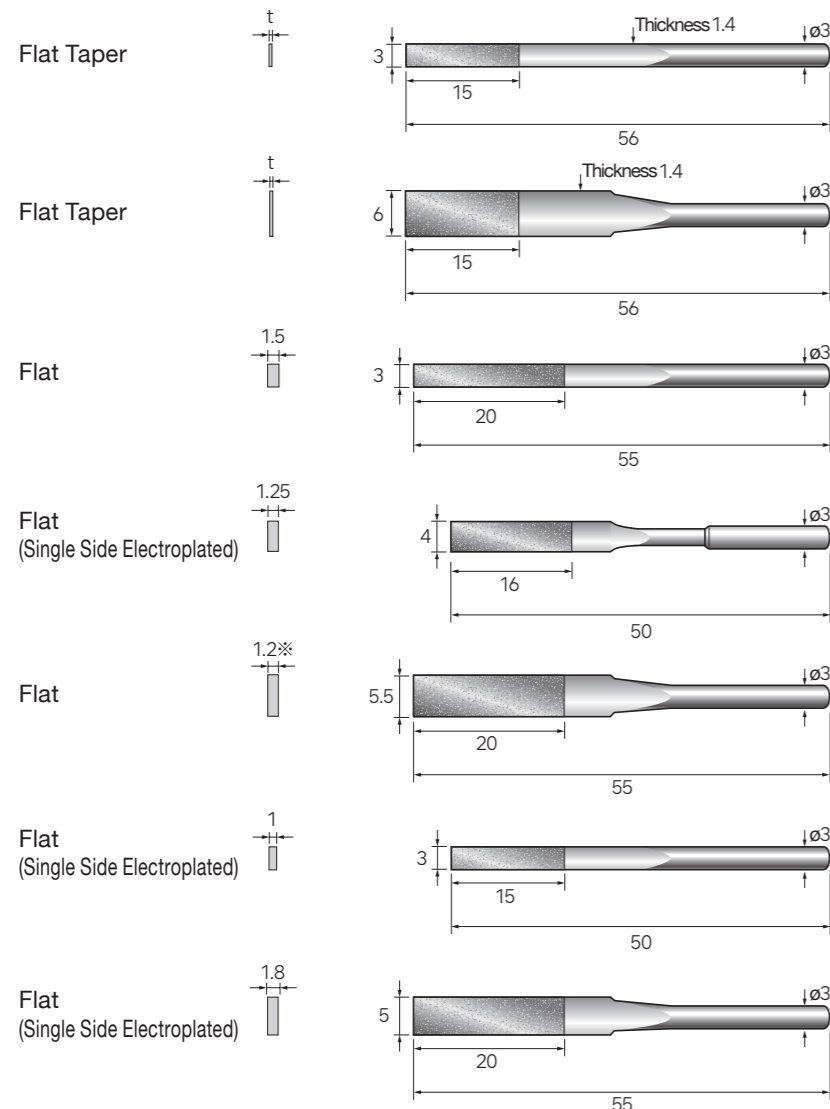

Thickness (t)	Grit Size	Code No.
0.5	#200	62801
0.4	#400	62802
0.35	#600	62803

0.5	#200	62805
0.4	#400	62806
0.35	#600	62807

#150	62811
#200	62812
#400	62813

#100	62814
------	-------

#150	62815
#200	62816
#400	62817

※ Thickness of 62815 is 1.4 mm.

#150	62821
#200	62822
#400	62823

#150	62825
#200	62826
#400	62827

2 pcs./pack

### Flat type 50 mm

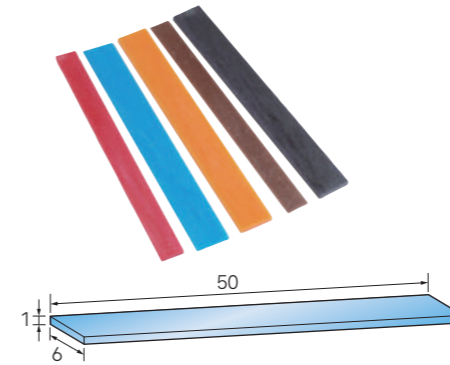

### Ceramic Fiber Grindstone Tip

Thickness 1 mm x width 6 mm

Grit Size	Color	Code No.
# 120	Violet	60516
# 220	Brown	60517
# 400	Orange	60518
# 800	Blue	60519
# 1200	Red	60520

### Round bar type 50 mm

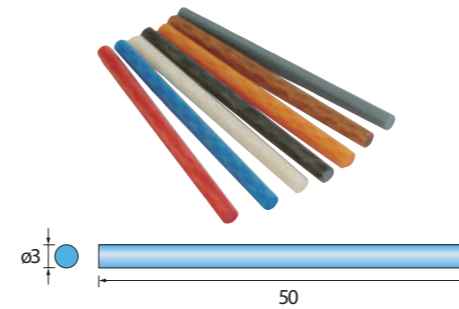

$\phi$ 3 mm

Grit Size	Color	Code No.
# 220	Gray	60551
# 300	Mazenta	60552
# 400	Orange	60553
# 600	Black	60554
# 800	Blue	60555
# 1000	White	60556
# 1200	Red	60557

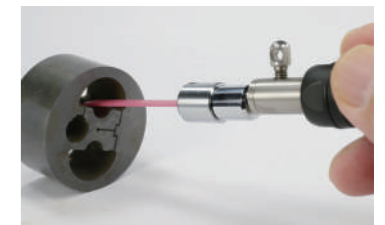

With 6 mm wide flat tip



With  $\phi$ 3 mm round bar



With sharpened tip of round bar

SHANK  $\phi$ 3.0 1 pc./pack

### Ceramic Fiber Holder

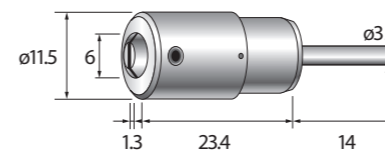

Max. clampable thickness 1 mm x width 6 mm

Code No.

62510

SHANK  $\phi$ 3.0 1 pc./pack

### Ceramic Fiber Brush

The grindstone is now in brush form.



Brush diameter	Brush length	Overall length	Finishing (Pink)	Middle Finishing (Red)	Rough Finishing (Blue)
$\phi$ 2	15	52*	51123	51133	51141
$\phi$ 2.5	15	52*	51124	51134	51142

※Blue's overall length is 50 mm.

▲ For safety reasons, always wear protective equipment such as safety glasses. Use at or below the indicated maximum allowable speed.

# 64101~

## Angle Type Grinder (Electric / Pneumatic) Exclusive Tools for "Angle Type"

# ~64274

SHANK DIAMETER

NAKANISHI Angle Grinders are available with a wide range of tools for a variety of machining operations, from cutting to grinding, polishing and lapping.

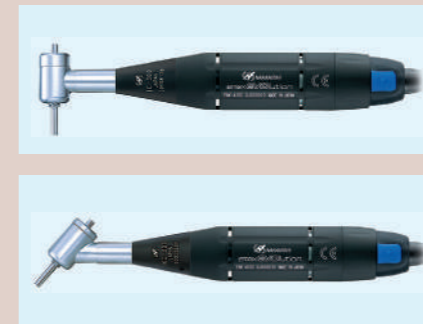
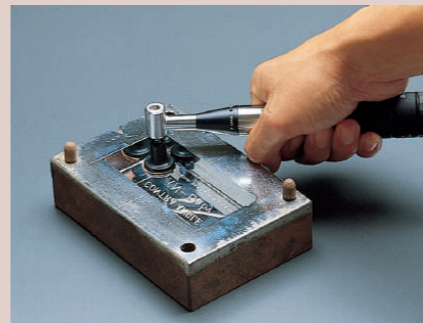

Angle Type



### Special Rubber Pads for Abrasive and Felt Discs

- It is used by attaching various types of polishing discs.
- The elasticity of the rubber makes it ideal for finishing flat and curved surfaces.

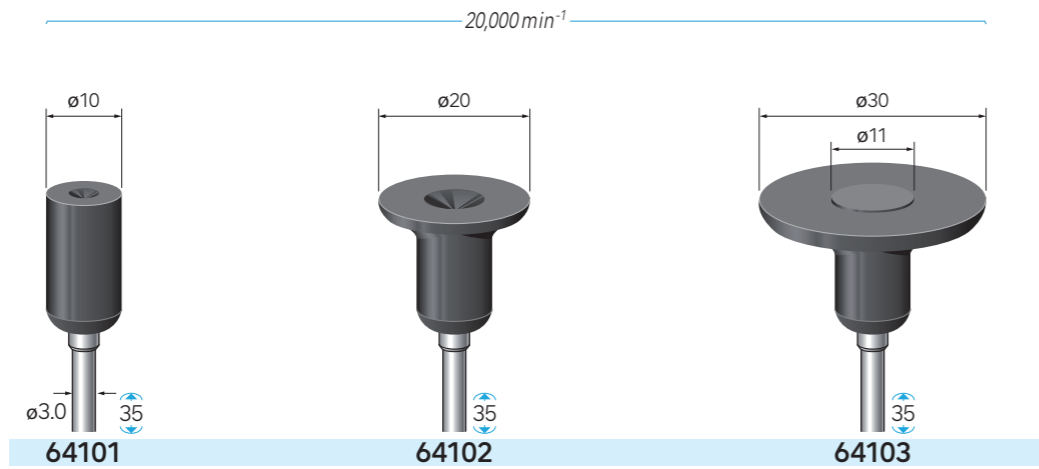

### Sandpaper Discs (paper base type)

- Suitable for metal, woodwork, painted surfaces and putty polishing
- Use in dry conditions



Adhesive Back				
Grit Size	ø11	ø21	ø31	
# 80	64201	64211	64221	
# 120	64202	64212	64222	
# 180	64203	64213	64223	
# 240	64204	64214	64224	
# 320	64205	64215	64225	
# 400	64206	64216	64226	
# 600	64207	64217	64227	



### Sandpaper Discs (fabric base type)

- Ideal for metalworking
- Excellent durability
- Use in dry conditions

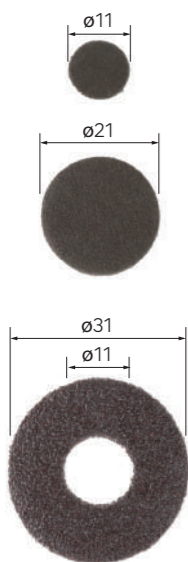

Adhesive Back				
Grit Size	ø11	ø21	ø31	
# 60	64111	64121	64141	
# 80	64112	64122	64142	
# 120	64113	64123	64143	
# 180	64114	64124	64144	
# 240	64115	64125	64145	
# 320	64116	64126	64146	
# 400	64117	64127	64147	
# 600	64118	64128	64148	



### Zirconia Disks

- These discs are specially coated with zirconia abrasive grains to provide excellent cutting performance and durability for difficult-to-machine materials.
- Ideal for machining metals such as aluminium, stainless steel, copper alloys and brass, which are prone to clogging.



Adhesive Back				
Grit Size	ø11	ø21	ø31	
# 60	64251	64261	64271	
# 80	64252	64262	64272	
# 120	64253	64263	64273	
# 150	64254	64264	64274	

# 64331 ~

## Angle Type Grinder (Electric / Pneumatic) Exclusive Tools for "Angle Type"

SHANK DIAMETER

NAKANISHI Angle Grinders are available with a wide range of tools for a variety of machining operations, from cutting to grinding, polishing and lapping.



# ~64432

Angle Type



20 pcs./pack

### Felt Discs

- Ideal for use in combination with various abrasives (diamond compound, polishing compound) for finish polishing.
- Made from 100% high quality sheep's wool, with moderate elasticity and sufficient durability for repeated polishing operations.
- High wool density ensures that abrasives and abrasive grains are held in place and the surface is polished.

Adhesive Back

Product name	ø11	ø21	ø31
Felt Discs (1 mm thick) Soft	<b>64331</b>	<b>64332</b>	<b>64333</b>
Felt Discs (2 mm thick) Soft	<b>64335</b>	<b>64336</b>	<b>64337</b>

\* Sheeted types are available.

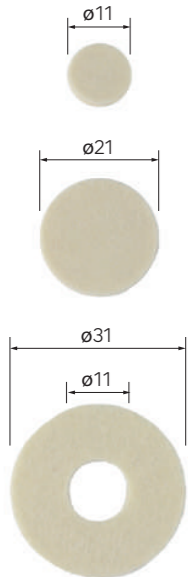

SHANK Ø3.0 5 pcs./pack

### Rubber grinding wheel disc with shaft (Integrated rubber pad)

- The newly developed special rubber holds the abrasive grains with the right amount of hardness and boasts exceptional polishing ability.
- The grinding wheel part is integrally moulded into the rubber pad for superior workability.
- Highly efficient finishing of flat and curved surfaces with a soft touch.

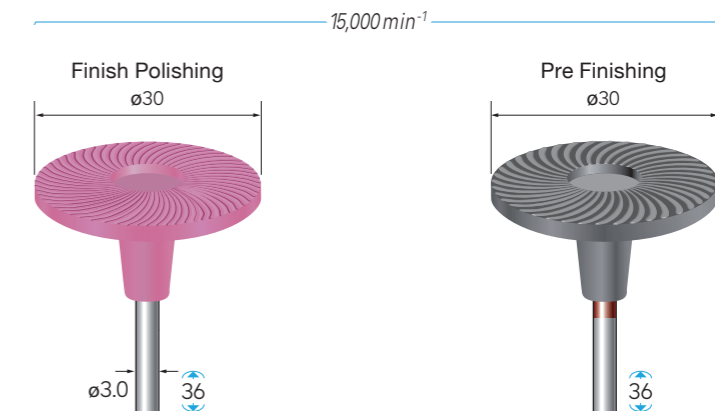
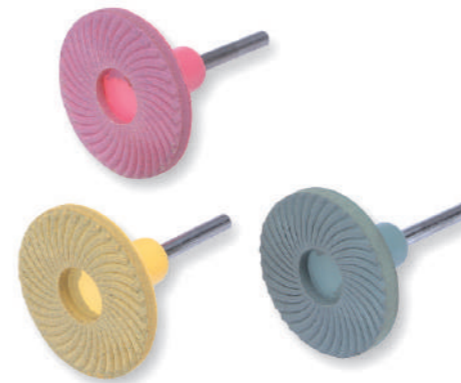

#### Finish Polishing

Grit Size	Color	WA abrasive grains	GC abrasive grains
# 80	Pink	<b>64411</b>	—
# 80	Purple	—	<b>64421</b>
# 120	Blue	<b>64412</b>	<b>64422</b>
# 180	Yellow	<b>64413</b>	—
# 180	Green	—	<b>64423</b>
# 220	Green	<b>64414</b>	<b>64424</b>
# 320	Purple	<b>64415</b>	<b>64425</b>
# 500	Orange	<b>64416</b>	—
# 500	Brown	—	<b>64426</b>

#### Pre Finishing (Excellent grindability)

Grit Size	Color	WA abrasive grains
# 80	Black(Red line)	<b>64431</b>
# 120	Black(Blue line)	<b>64432</b>

## Angle Type Grinder (Electric / Pneumatic) Exclusive Tools for "Angle Type"

NAKANISHI Angle Grinders are available with a wide range of tools for a variety of machining operations, from cutting to grinding, polishing and lapping.

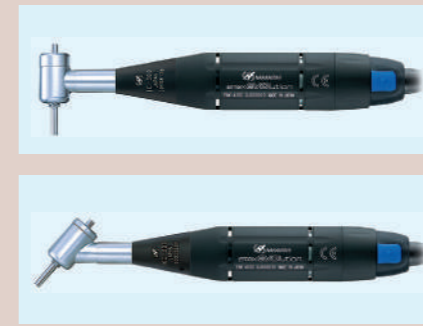

Angle Type

1 pc./pack

### Diamond Discs (Full electroplated surface)

The base material is an ultra-thin copper alloy, with diamond abrasive grains electroplated over the entire surface.

- The metal base material has good electrodeposition plating conditions and adheres diamond abrasive grains uniformly and most firmly.
- Very good sharpness and durability.

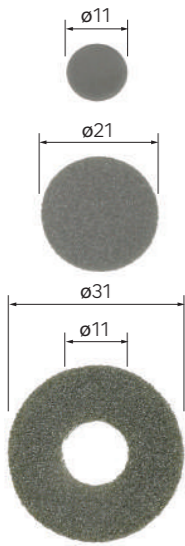

Adhesive Back

Grit Size	ø11	ø21	ø31
# 100	64451	64461	64471
# 140	64452	64462	64472
# 200	64453	64463	64473
# 280	64454	64464	64474
# 400	64455	64465	64475
# 600	64456	64466	64476
# 800	64457	64467	64477
# 1000	64458	64468	64478

\* Sheeted types are available.

3 pcs./pack

### Resin Bond Diamond Discs

Diamond abrasive grains are mixed with resin bond and coated on the resin base material.

- The resin component provides a uniform and stable finished surface and a soft grinding feel.
- ※ This resin bond type requires dressing only for the first use.  
The cutting edges of the abrasive grains are exposed by lightly shaving the surface with a grindstone or diamond file.



Adhesive Back

Grit Size	ø11	ø21	ø31
# 80	64531	64541	64551
# 120	64532	64542	64552
# 180	64533	64543	64553
# 240	64534	64544	64554
# 400	64535	64545	64555
# 800	64537	64547	64557
# 1000	64538	64548	64558
# 2000	64539	64549	64559

1 pc./pack

### Diamond Discs (Dot electroplated type for wet applications)

Nickel alloy pellets with diamond electrodeposition are strongly bonded to the Resin base material.

- The dot pattern is characterized by its strong grinding performance.
- Dot spaces allow chips and grinding fluid to flow smoothly.
- The resin base material is made of a fiber-filled resin that excels in flexibility and toughness.

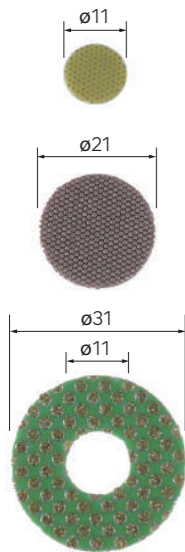

Adhesive Back

Grit Size	Color	ø11	ø21	ø31
# 60	Green	64501	64511	64521
# 120	Black	64502	64512	64522
# 200	Red	64503	64513	64523
# 400	Yellow	64504	64514	64524
# 800	Gray	64505	64515	64525

\* Sheeted types are available.

# 11131~

SHANK DIAMETER

SHANK  $\phi 1.6$

MINI Angle Type



## Angle Type Grinder (Electric / Pneumatic) Exclusive Tools for "MINI ANGLE Type"

NAKANISHI Angle Grinders are available with a wide range of tools for a variety of machining operations, from cutting to grinding, polishing and lapping.

### Diamond Burs for Deep Hole Chamfering

SHANK  $\phi 1.6$  1 pc./pack Diamond Burs for Deep Hole Chamfering

- Ideal for machining hardened steel, cemented carbide, ceramics, etc.

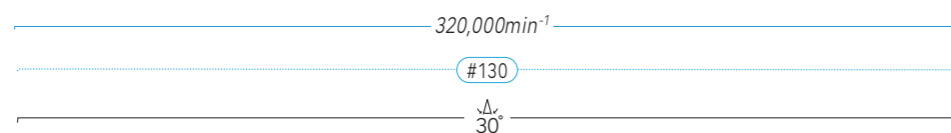
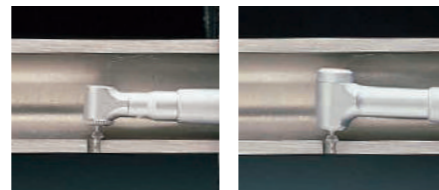

Diamond abrasive grains

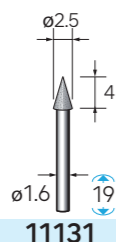

11131

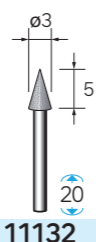

11132

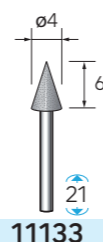

11133

SHANK  $\phi 1.6$  1 pc./pack Diamond Burs for Deep Hole Chamfering

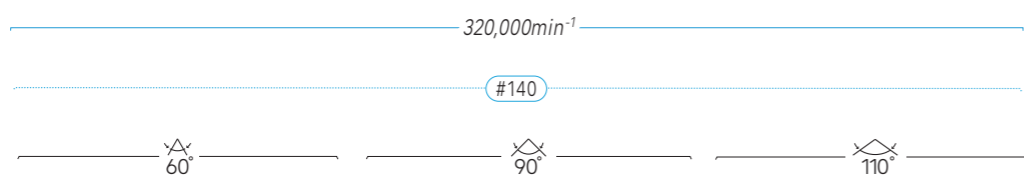

Diamond abrasive grains

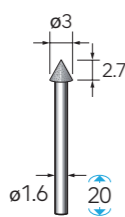

11151

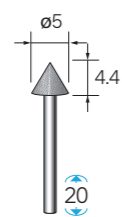

11152

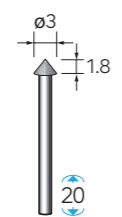

11153

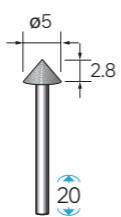

11154

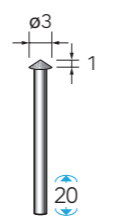

11155

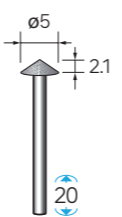

11156

Tools of  $\phi 1.6$  mm shank

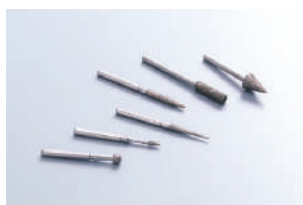

Diamond Burs



Carbide Burs

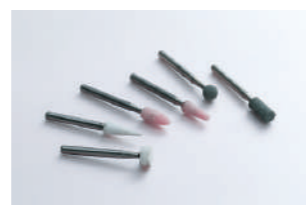

Mounted Abrasive Points



Abrasive Rubber Points



## Compact Handy Belt Sander (Electric / Pneumatic) Exclusive Tools for "FINE BELT SANDER"

Powerful belt grinding power. High-quality special belt for processing as desired. The precise, lightweight, and compact NAKANISHI Belt Sander functions at 100%.

# ~65027

Fine Belt Sander

### Sand Belt

30 pcs./pack Circumference 300 mm



- High quality Sanding Belt with excellent grindability and durability.
- Highly efficient grinding with a soft touch and less grain dropout even at high rim speeds.

● Assorted set for Pre Finishing (● mark)  
4 Grit sizes (10 pcs. each)  
Total 40 pcs. per pack

No.64931

● Assorted set for Finishing (● mark)  
4 Grit sizes (10 pcs. each)  
Total 40 pcs. per pack

No.64932

For metal processing

	W=4 mm	W=6 mm	W=8 mm
<b>Grit Size</b>	Code No.	Code No.	Code No.
# 80	64901	64911	64921
# 120	64902	64912	64922
# 180	64903	64913	64923
# 240	64904	64914	64924
# 320	64905	64915	64925
# 400	64906	64916	64926
# 600	—	—	64927
# 800	—	—	64928

### Zirconia Belt

30 pcs./pack Circumference 300 mm



- Ideal for machining metals such as aluminium, stainless steel, copper alloys and brass, which are prone to clogging.
- These belts are specially coated with zirconia abrasive grains to provide excellent durability for difficult-to-grind materials.

● Assorted set 8 mm width  
All 3 Grit sizes (10 pcs. each)  
Total 30 pcs.

No.64975

Grit Size	Code No.
# 80	64971
# 100	64972
# 120	64973

### Diamond Belt

3 pcs./pack Hard type (circumference 300 mm)



- Excellent cutting performance enables high productivity and cost reduction.
- Excellent wear resistance and durability, and stable finish machined surfaces can be maintained.
- Suitable for highly efficient machining of carbide, hardened steel, mold steel, special steel, ceramics, FRP, carbon fiber, glass, stone, and difficult-to-machine materials.

● Assorted set 8 mm width  
All 5 Grit sizes (1 pc. each)  
Total 5 pcs.

No.65019

Hard type

Grit Size	Code No.	Grit Size	Code No.
# 80	65011	# 320	65015
# 120	65012	# 600	65017
# 240	65014		

3 pcs./pack Soft type (circumference 300 mm)



● Assorted set 8 mm width  
All 8 Grit sizes (1 pc. each)  
Total 8 pcs.

No.65030

Soft type

Grit Size	Code No.	Grit Size	Code No.
# 120	65021	# 400	65028
# 180	65022	# 600	65025
# 240	65023	# 800	65026
# 320	65024	# 1000	65027